

MOTOR SPECIFICATIONS

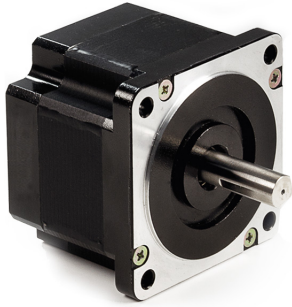

Part Number	8718M-16S
NEMA Size	NEMA 34
Frame Size	86.1mm (3.4 in)
Step Angle	1.8 deg/step
Body Length (Dim. A)	97mm (3.8 in)
Current	3.15 Amps/Phase
Holding Torque	6.08 Nm (861 oz-in)
Resistance	1.2 Ohm/Phase
Rotor Inertia	2706.94 g-cm ² (14.8 oz-in)
Number of Leads	4
Connection	Serial
Weight	2.7 kg (5.94 lb)

DIMENSIONS

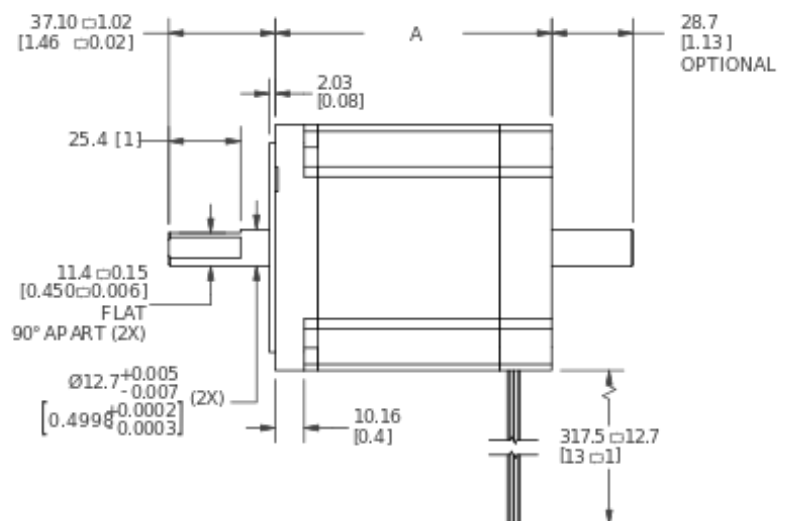
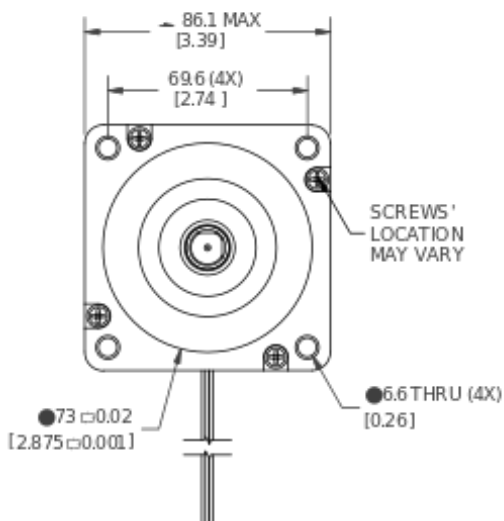

PERFORMANCE CURVE

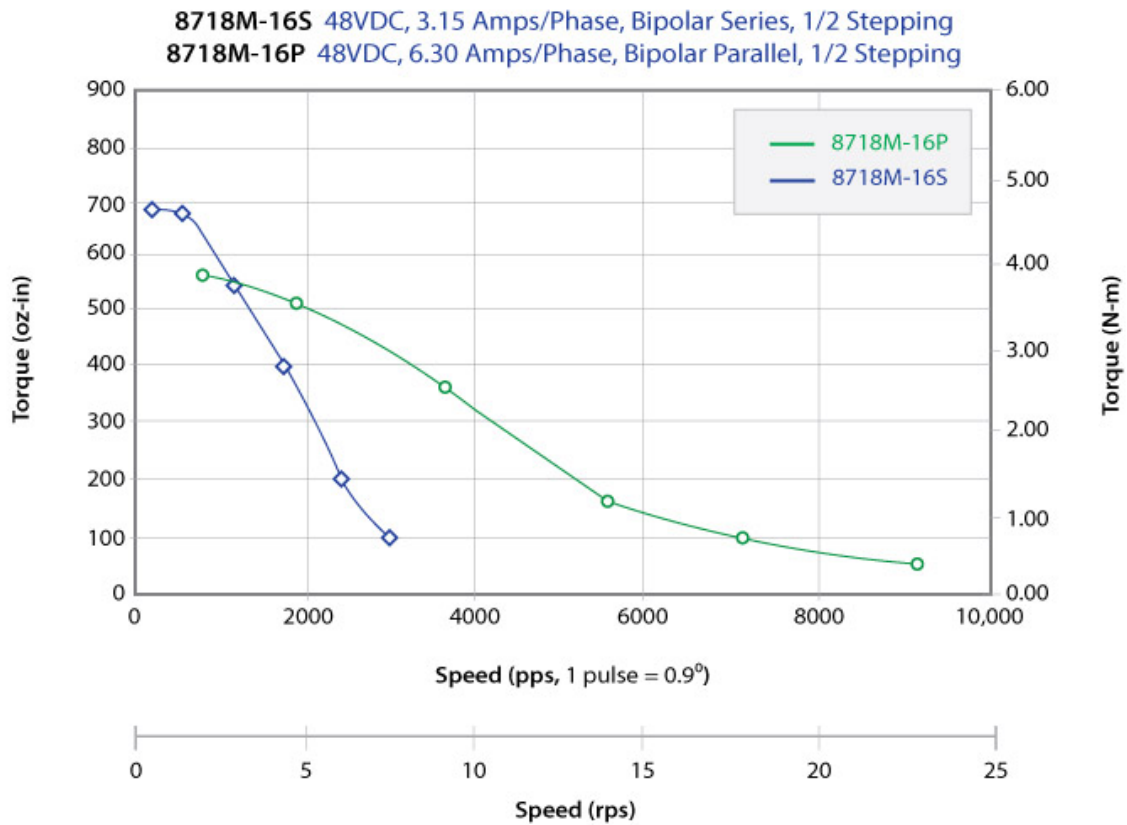

OPERATING CONDITIONS

Radial Play	0.03 mm max @ 0.45 kg load (0.001 in max @ 1 lb load)
End Play	0.08 mm max @ 1.36 kg load (0.003 in max @ 3 lb load)
Shaft Run Out	0.05 mm TIR (0.002 in TIR)
Concentricity of Mounting Pilot to Shaft	0.08 mm TIR (0.003 in TIR)
Perpendicularity of Shaft to Mounting Face	0.08 mm TIR (0.003 in TIR)
Max Axial Load	2.72 kg (6 lb)
Maximum Case Temperature	80 deg C
Ambient Temperature	-20 to 50 deg C
Storage Temperature	-20 to 100 deg C
Humidity Range	85% or less, non-condensing
Magnet Wire Insulation	Class B 180° C*
Insulation Resistance	100 Ohm at 500 VCD
Dielectric Strength	500 VCD for 1 min

OPERATION & USAGE TIPS



Do not disassemble motors; a significant reduction in motor performance will occur.



Do not machine shafts; this will have a negative effect on shaft run out and perpendicularity.



Do not disconnect motor from drive while in operation.



Do not use holding torque/detent torque of motor as a fail safe brake.



Do not hold motor by lead wires.



Do not exceed the rated current; this will burn the motor.

FAILURE TO COMPLY WITH THESE RECOMMENDATIONS WILL VOID ALL WARRANTY TERMS

WIRING TABLE

COLOR	FUNCTION
Red	A+ Phase
Blue	A- Phase
Green	B + Phase
Black	B- Phase

RECOMMENDED DRIVERS/CONTROLLERS



Single Axis Controller+Driver
R356



Microstepping Driver
R701P-RO

Motion Control, **Solved.**

MOTOR ENGINEERING & MANUFACTURING



Optimized
For Your
Application



Quick
Prototype
Turnaround



Small Batch
to OEM Volume
Production



US Based
Support &
Manufacturing